

Electric Circuits for Physicists 2018

Shingo Katsumoto

2018年度
電子回路論 第1回

東京大学
理学部・理学系研究科
物理学専攻
物性研究所
勝本信吾

ノート・資料等の置き場

<http://kats.issp.u-tokyo.ac.jp/kats/circuit4/>

物理屋のための「電子回路論」講義ノート etc. 2018

Lecture note "Electric Circuit for Physicists" 2018

[English](#) [勝本のページ](#)

講義にあたって

講義ノート

Notes in English

練習問題・レポート

Exercise・Report

2018年度「電子回路論」受講生の皆さま

本年度2年ぶりにまた「電子回路論」を担当することになりました(4回目)。これまでの「ノート」のページにも書いているように、「電子回路」を語ることは大好きなのですが、まとまった物理の「講義」にすることは大変だと感じています。これから大学院に進まれたり、あるいはすでに大学院で研究を行われていたりする方にとって、電子回路論は大変重要だと思っており、これを皆さんにちゃんと伝えられているか、心配な日々が半年続くこととなります。

内容は、これまでとほぼ同じになる予定です。したがって、[2年目の講義ノート](#)、あるいは[3年目の講義ノート](#)等を見ていただければ、大体のことはわかることとなります。しかし、一応、今年度も多少は資料に手を入れていこうと思っています。時間が許せば、ですが、最近物理実験でも期待以上の効果が挙がっている機械学習についても多少紹介できれば、と考えていますが、どうなりますか。

海外からの受講生が増えていることを受け、拙い英語で講義しております。英語がまずくてわかりにくい時は、遠慮なく聞いていただければ、英語および日本語にてお答えいたします。

勝本信吾

Dear Students for "Electric circuits for physicists",

I have been assigned to the lecturer of "Electric circuits" in FY2016 just as in the two preceding fiscal years. For me it is a big fun to talk on "Electric circuits", but the matter is different when I give you the knowledges as "Lectures on electric circuits". Such knowledges and understandings are very important especially for whom going into resesarchs in graduate course. I should be careful, then, in this half a year, to convey the fun of electric circuits.

2週に1回簡単な練習問題を出題 → 2週間以内に解答を提出
TAが採点してコメントをメール送付します
試験は期末レポート。練習問題と合わせて採点します

シラバス

1. 電磁場と電子回路
 - 1.1 この講義について
 - 1.2 電子回路とは
 - 1.3 2端子素子
 - 1.4 回路図
 - 1.5 抵抗器
 - 1.6 キャパシタ
 - 1.7 インダクタ
2. 線形回路序論
 - 2.1 線形システムと電子回路
 - 2.2 電源
 - 2.3 回路網
 - 2.4 4端子(2端子対)回路
 - 2.5 端子対回路の諸定理
 - 2.6 双対性
 - 2.7 受動素子と能動素子
3. 伝達関数と周波数応答・過渡応答
 - 3.1 受動素子2端子回路の伝達関数
 - 3.2 2端子受動素子回路
 - 3.3 受動素子回路の過渡応答
4. 増幅回路
 - 4.1 増幅回路と系の制御
 - 4.2 OPアンプ
 - 4.3 トランジスタ
 - 4.4 電場効果トランジスタ
5. 分布定数回路
 - 5.1 伝送路
 - 5.2 伝送路の伝播現象
 - 5.3 S行列(Sパラメタ)
 - 5.4 シュレディンガー方程式とLC伝送路

シラバス2

- 6. 信号, 雑音, 波形解析
 - 6.1 ゆらぎ
 - 6.2 増幅器の雑音
 - 6.3 変調とアナログ信号伝送
 - 6.4 離散化信号

- 7. デジタル信号とデジタル回路
 - 7.1 デジタル信号序論
 - 7.2 論理ゲート
 - 7.3 論理ゲートの実装
 - 7.4 論理演算の回路化と簡単化
 - 7.5 A-D/D-A コンバータ
 - 7.6 デジタルフィルター
 - 7.7 ハードウェア記述言語 : HDL

1. Electromagnetic field and electric circuits
 - 1.1 About this lecture
 - 1.2 What is electric circuit?
 - 1.3 Two-terminal devices
 - 1.4 Circuit diagrams
 - 1.5 Resistors
 - 1.6 Capacitors
 - 1.7 Inductors
2. Introduction to linear circuits
 - 2.1 Linear systems and electric circuits
 - 2.2 Power sources
 - 2.3 Networks
 - 2.4 4-terminal (2-terminal pair) circuits
 - 2.5 Theorems in terminal pair circuits
 - 2.6 Duality
 - 2.7 Passive devices, active devices

3. Transfer function and transient response
 - 3.1 Transfer function of passive two-terminal pair circuits
 - 3.2 Two-terminal passive circuits
 - 3.3 Transient response of passive circuits
4. Amplifiers
 - 4.1 System control and amplifiers
 - 4.2 Operational amplifiers
 - 4.3 Transistors
 - 4.4 Field effect transistors
5. Distributed constant circuits
 - 5.1 Transmission lines
 - 5.2 Propagation through transmission lines
 - 5.3 S matrix (S parameters)
 - 5.4 Schrodinger equation and LC transmission circuit

6. Signal, noise, waveform analysis
 - 6.1 Fluctuation
 - 6.2 Noise from amplifiers
 - 6.3 Modulation and analog signal transfer
 - 6.4 Discrete signal
7. Digital signal and digital circuits
 - 7.1 Introduction to digital signal
 - 7.2 Logic gates
 - 7.3 Logic circuits implementation
 - 7.4 Circuit implementation and simplification of logic operation
 - 7.5 AD/DA converters
 - 7.6 Digital filters
 - 7.7 Language to describe hardware: HDL

Outline Today

1. Electromagnetic field and electric circuits
 - 1.1 About this lecture
 - 1.2 What is electric circuit?
 - 1.3 Circuit diagrams
 - 1.4 Two-terminal devices
 - 1.5 Resistors
 - 1.6 Capacitors
 - 1.7 Inductors
2. Introduction to linear circuits
 - 2.1 Linear systems and electric circuits

Ch.1 Electromagnetic field and electric circuits



For what this lecture is?

Experimentalists:

Knowledges on electric circuit are indispensable.

Purposes:

Understand how circuits work.

Design circuits along research plans

General physicists:

Meta physics

Coupled pendulum and neutrino oscillation



Pendulum oscillation

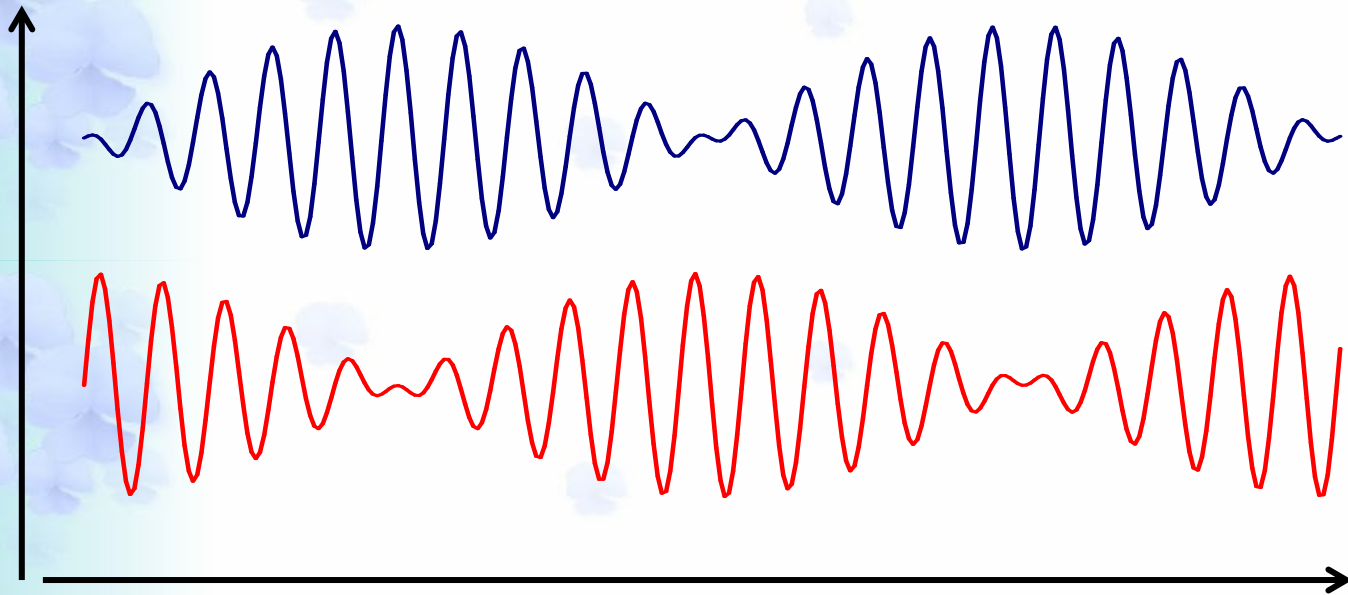

time

Electric Circuit: A treasure house of concept and language

Electric Circuit

Electromagnetic Field

- Lumped constant Circuit
- Distributed constant Circuit

Signal

- Noise
- Modulation
- Discrete signal

Material Science

- Metal
- Semi-conductor
- Ferromagnet

Linear response

- Transfer function
- Resonance
- Transient response

System stability

- Amplifier
- Feedback
- Nyquist diagram

Analog and digital

- Fourier tr.- z-tr.
- Analog filter - Digital filter

1.2 What is electric circuits?: Thunderbolt struck a plane!

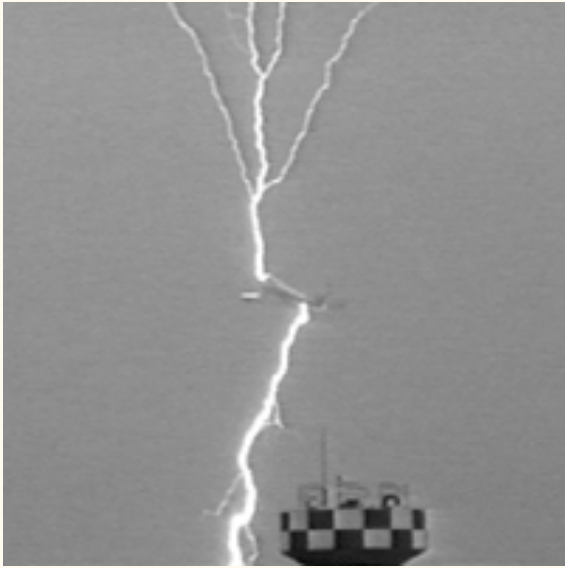

Your answer?

1.



Fell down and crashed

2.



Damaged

3.



Nothing happened

Plasma frequency

$$m \frac{d^2 x}{dt^2} = -eE$$

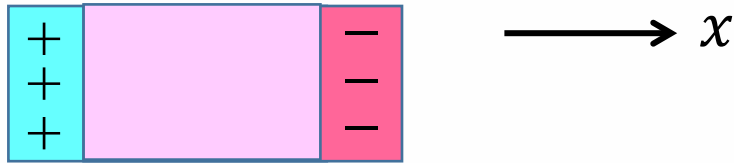

$$E = E_0 e^{-i\omega t}, \quad x = x_0 e^{-i\omega t} \rightarrow m\omega^2 x_0 = eE_0$$

$$\text{Electric polarization: } P = -n e x_0 = -\frac{n e^2 E_0}{m \omega^2}$$

$$\epsilon(\omega) = \frac{D(\omega)}{\epsilon_0 E(\omega)} = 1 + \frac{P(\omega)}{\epsilon_0 E(\omega)} = 1 - \frac{n e^2}{\epsilon_0 m \omega^2} = 1 - \frac{\omega_p^2}{\omega^2}$$

$$\omega_p^2 \equiv \frac{n e^2}{\epsilon_0 m} \quad : \text{ Plasma frequency}$$

$$\text{Cu: } n = 8.5 \times 10^{22} / \text{cc} \quad m^* = 1.3 m_0$$

$$f_p = \omega_p / (2\pi) = 2.3 \times 10^{15} \text{ Hz} \quad \lambda = 130 \text{ nm Near ultra-violet}$$

Metals are super-screening materials!

Equipotential lines

1.3 Various circuit diagrams



三田無線研究所
DELICA DX-CS-7

Picture diagram

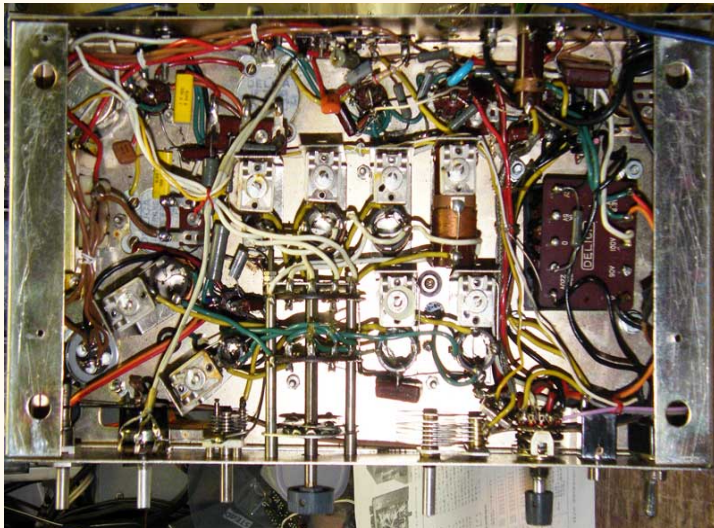
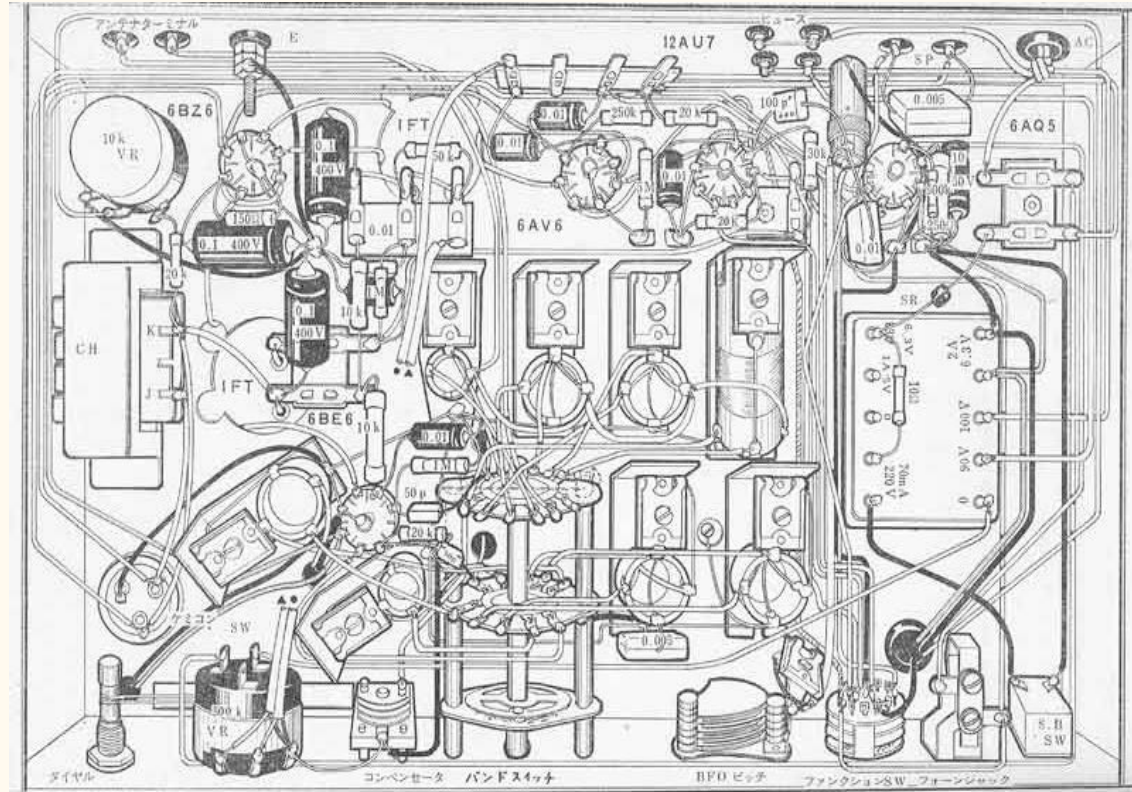

Various circuit diagrams

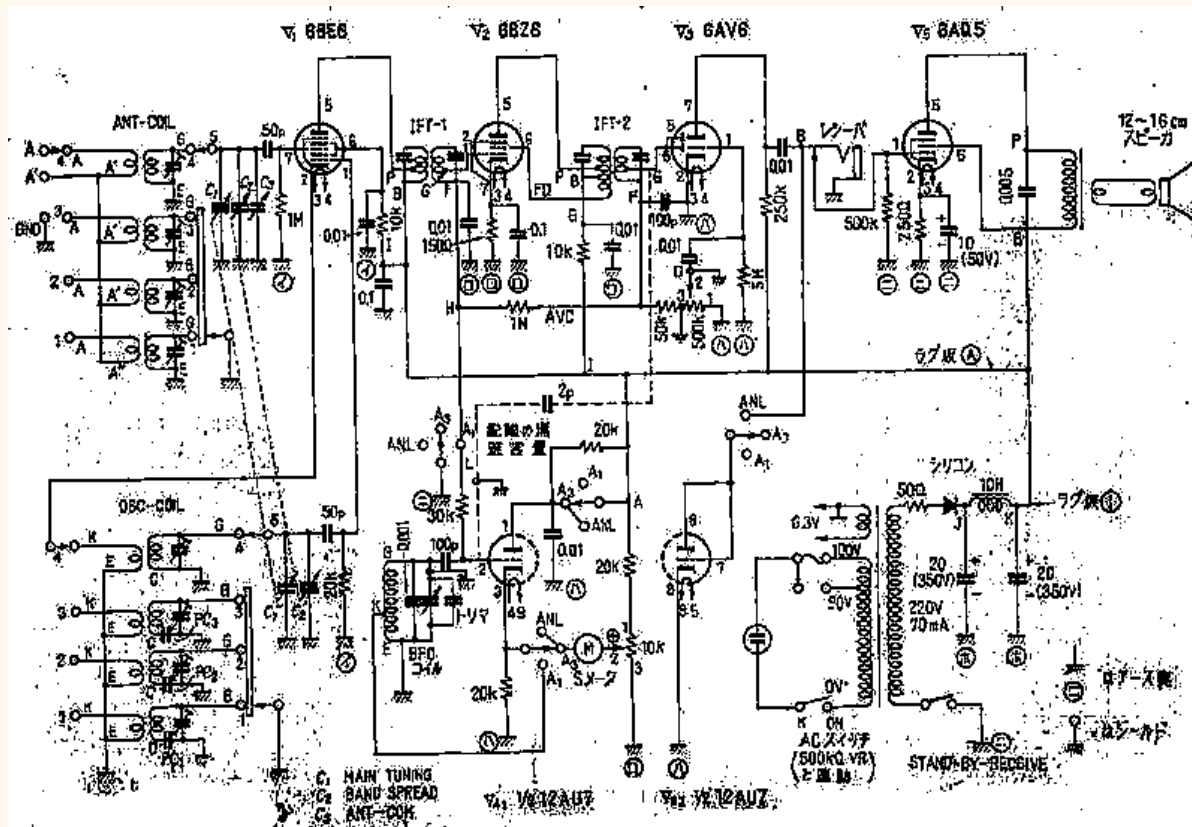

Parts + Wiring
= Wiring (Circuit) diagram

Block diagram

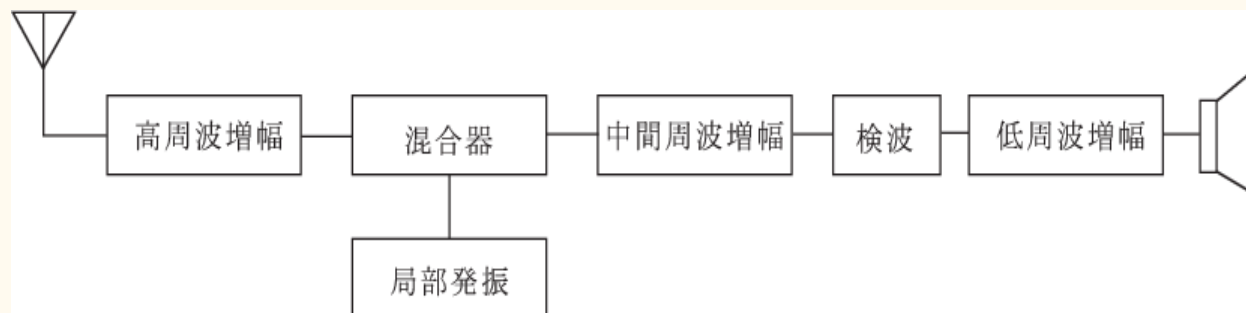

Various circuit diagrams (2)

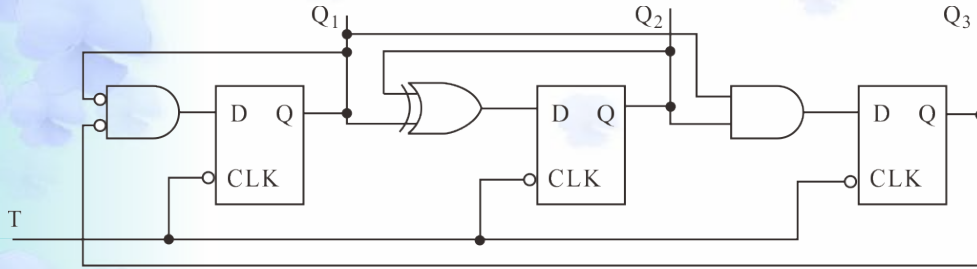

Digital circuit:
logic gates + signal flow

```
-- Library declaration -----
library IEEE;
use IEEE, STD_LOGIC_1164.ALL;
use IEEE, STD_LOGIC_UNSIGNED.ALL;
-- Entity declaration -----
entity COUNTER is
generic (WIDTH : integer := 4);
port (CLK, RESET, LOAD, INC : in          std_logic;
      DATA : in          std_logic_vector(WIDTH-1 downto 0);
      COUNT : out std_logic_vector(WIDTH-1 downto 0);
);
end COUNTER;
-- Architecture declaration -----
architecture RTL of COUNTER is
signal COUNT_TMP : std_logic_vector(WIDTH-1 downto 0);
begin
COUNT <= COUNT_TMP;
```

Can be described with a hardware
description language

No physics ?

Neural network

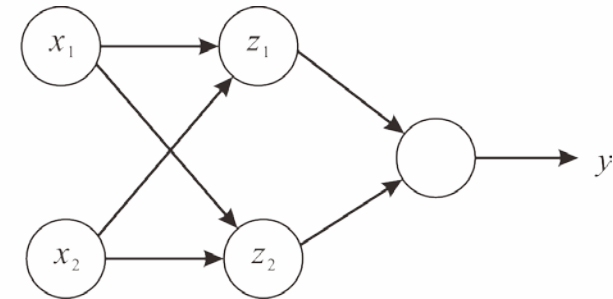
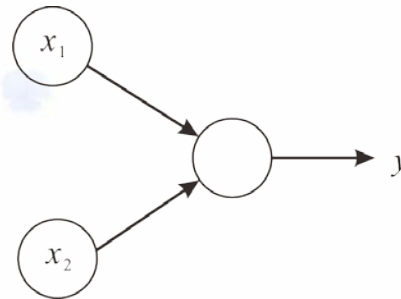
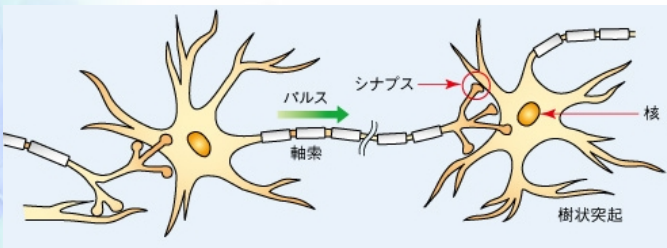

Wirings in electric circuits

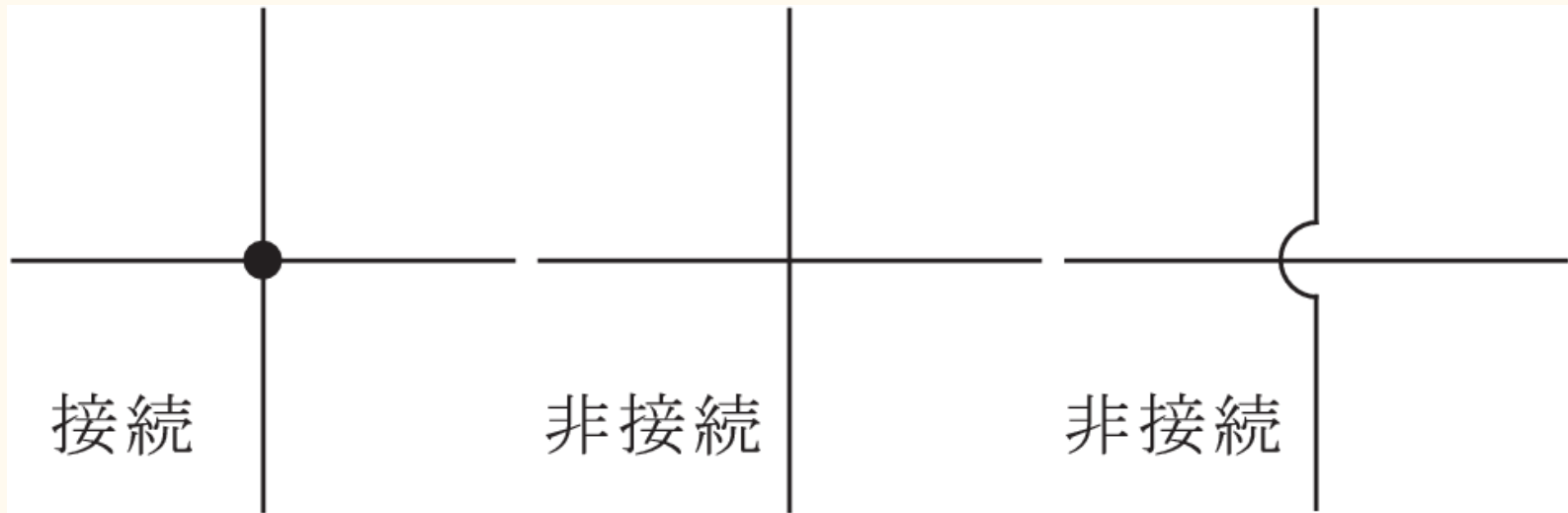

Connected

Not connected

Not connected

Violate electromagnetism theory

Concept of local electromagnetic field

= Lumped constant circuits (集中定数回路)

Circuit symbols for two-terminal devices

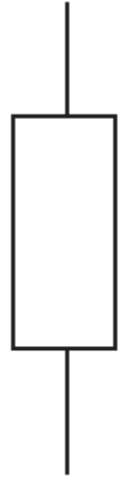

固定抵抗器

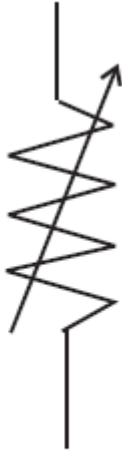

可変抵抗器



コンデンサ



可変
コンデンサ

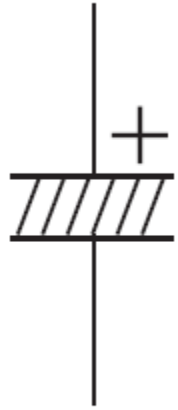

極性電解
コンデンサ

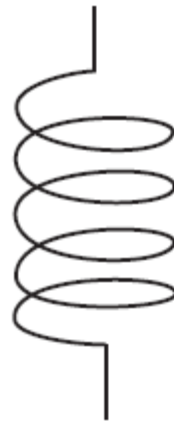

空芯コイル

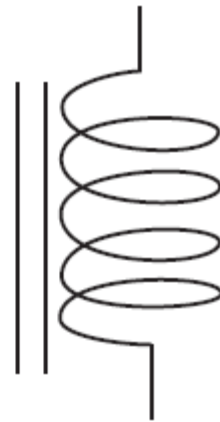

磁性体入り
コイル

Basic concepts in electric circuits

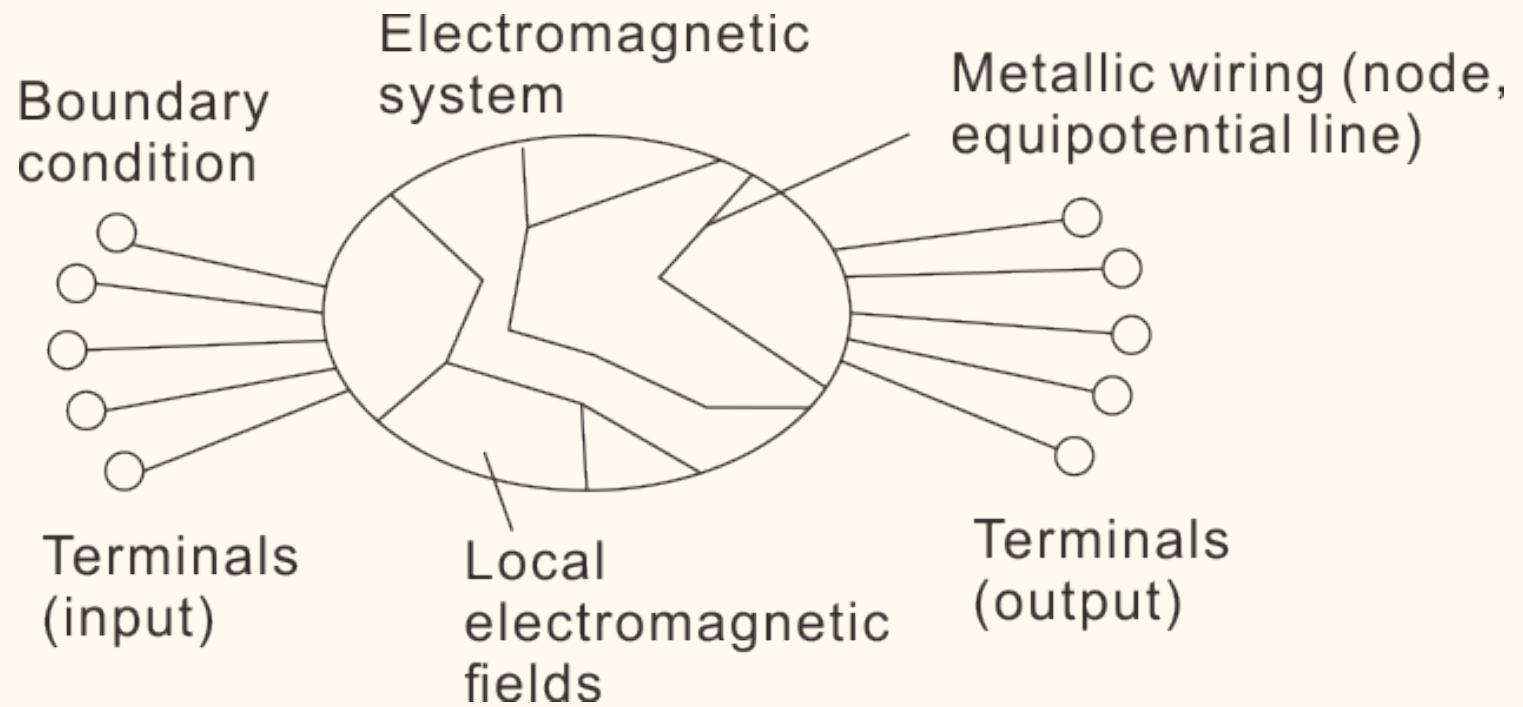

What is current-voltage characteristics?

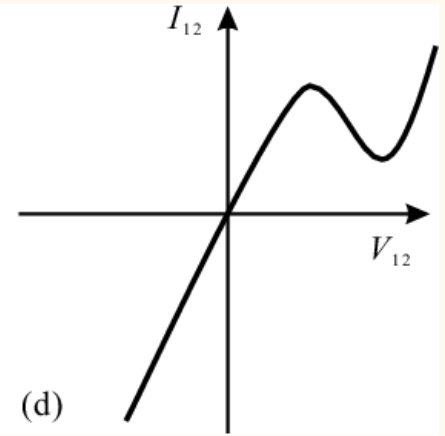
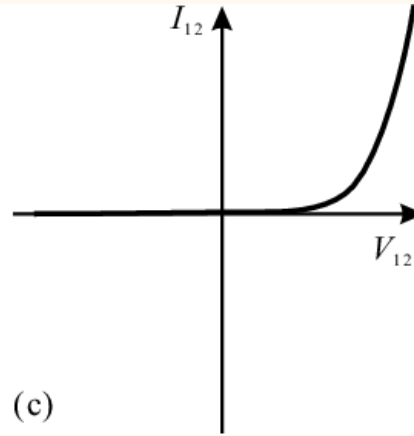
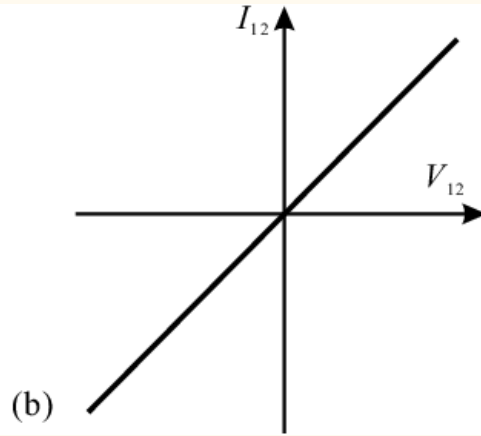
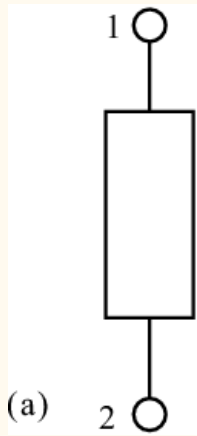

Resistor

What is current-voltage characteristics?

Curve tracer

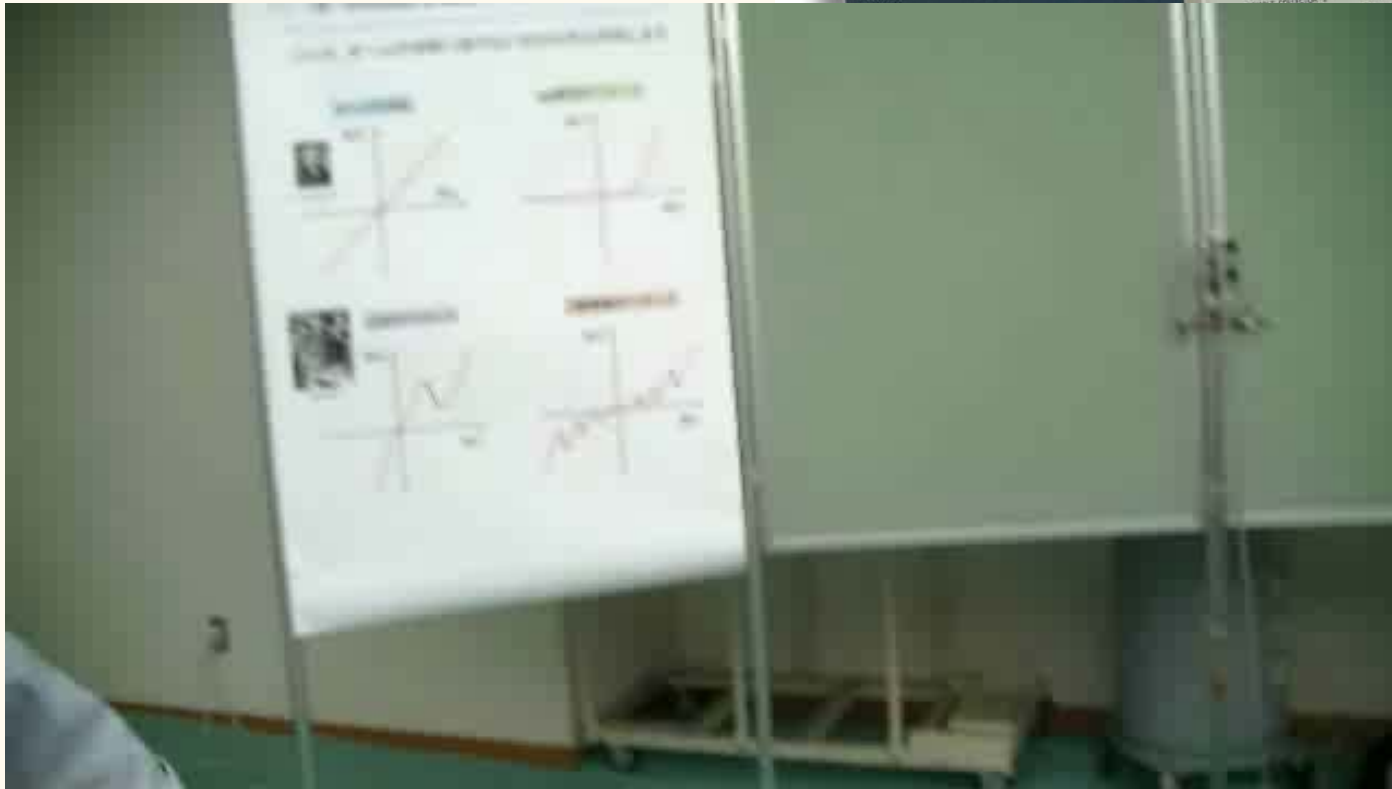

Variable resistors

Slide

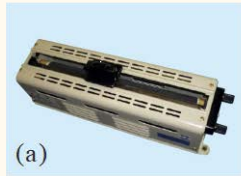

(a)



(b)



(c)



(d)

Carbon helical

Helical
potentiometer

Rotary switch
potentiometer

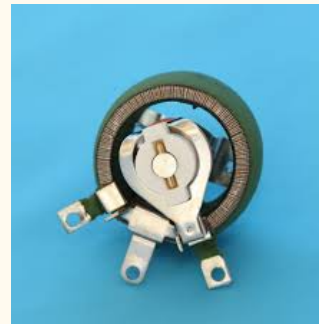
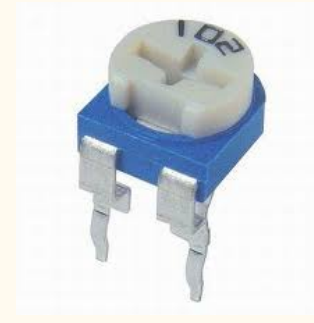
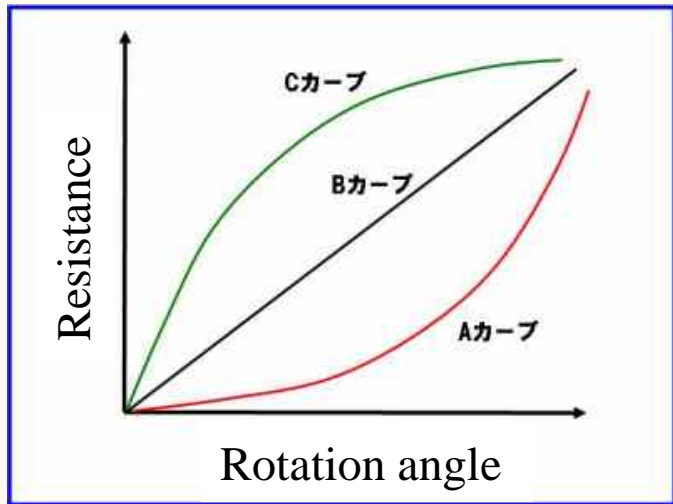

trimmer

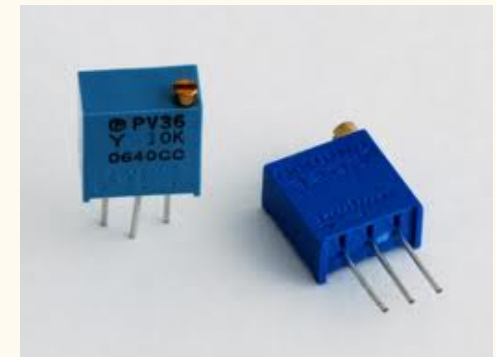

Cermet trimmer

Fixed resistors

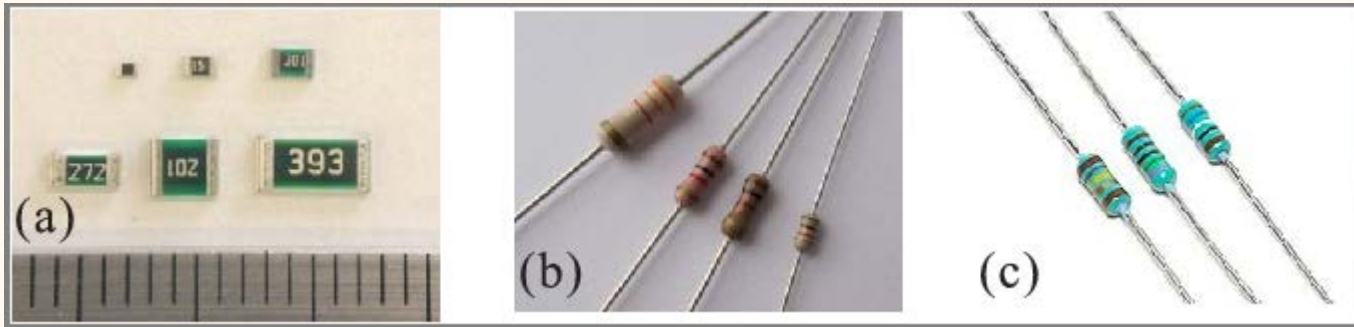

Chip resistors

Carbon film resistors

Metallic film resistors (spiral)

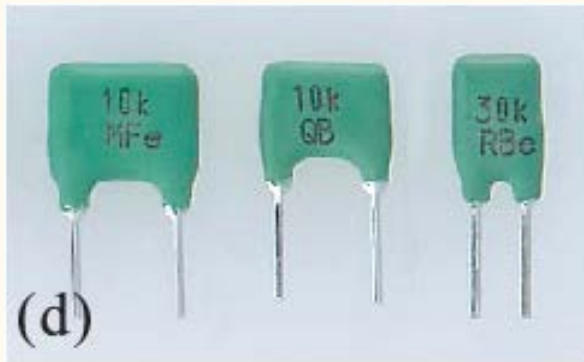

Metallic film resistors (meander)

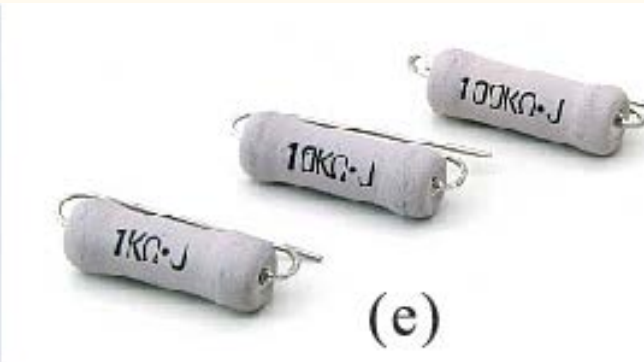

High power type

抵抗器のカラーコード

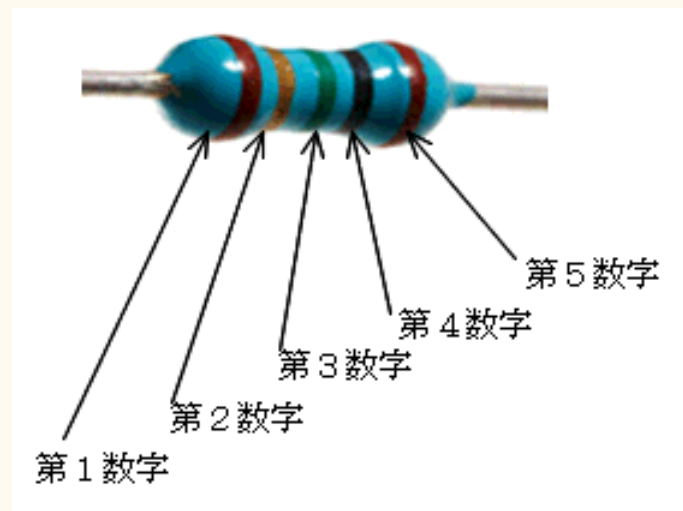
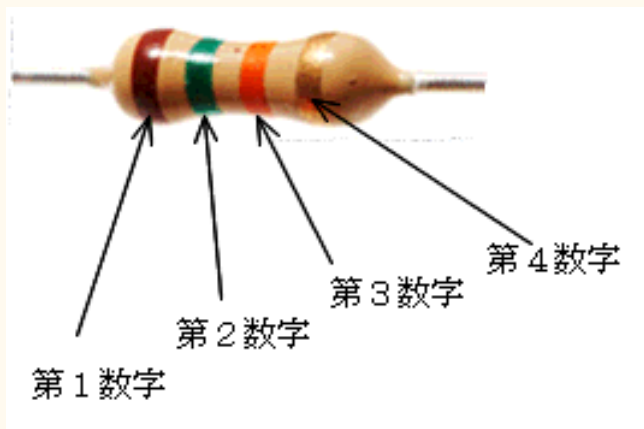

色	第1数字	第2数字	第3数字	第4数字	第5数字
黒	0	0	0	10^0	X
茶	1	1	1	10^1	±1%
赤	2	2	2	10^2	±2%
橙	3	3	3	10^3	X
黄	4	4	4	10^4	X
緑	5	5	5	10^5	X
青	6	6	6	10^6	X
紫	7	7	7	10^7	X
灰	8	8	8	10^8	X
白	9	9	9	10^9	X
金	X	X	X	10^{-1}	±5%
銀	X	X	X	10^{-2}	±10%
無色	X	X	X	X	±20%

Color code for resistors

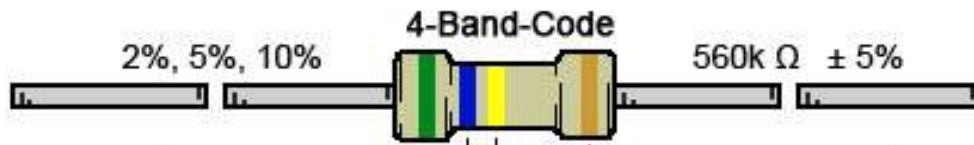

COLOR	1 ST BAND	2 ND BAND	3 RD BAND	MULTIPLIER	TOLERANCE
Black	0	0	0	1 Ω	
Brown	1	1	1	10 Ω	\pm 1% (F)
Red	2	2	2	100 Ω	\pm 2% (G)
Orange	3	3	3	1K Ω	
Yellow	4	4	4	10K Ω	
Green	5	5	5	100K Ω	\pm 0.5% (D)
Blue	6	6	6	1M Ω	\pm 0.25% (C)
Violet	7	7	7	10M Ω	\pm 0.10% (B)
Grey	8	8	8		\pm 0.05%
White	9	9	9		
Gold				0.1 Ω	\pm 5% (J)
Silver				0.01 Ω	\pm 10% (K)

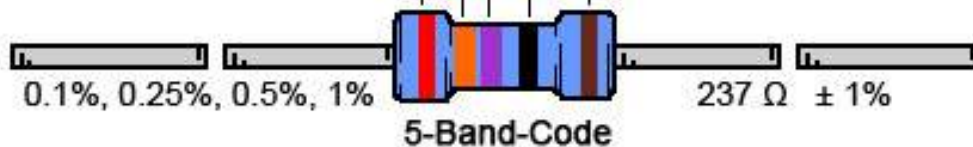

Big
boys
race
our
young
girls
but
Violet
generally
wins.

Variable capacitors

$$C = \epsilon\epsilon_0 \frac{S}{d}$$



(a)

Steatite

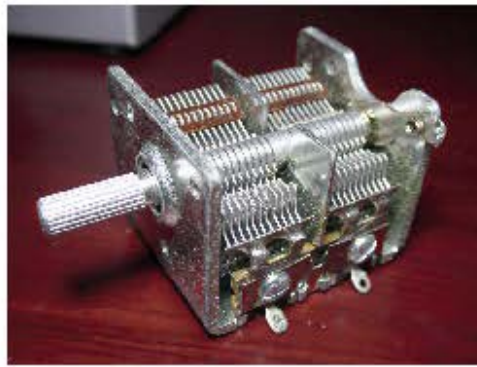

(b)

Tandem



(c)

Poly-Ethylene



(d)

Ceramic

Air capacitor

Fixed capacitors

Ceramic capacitors

Single disk pair type

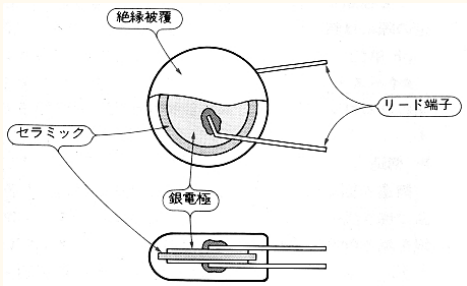

Stacked type

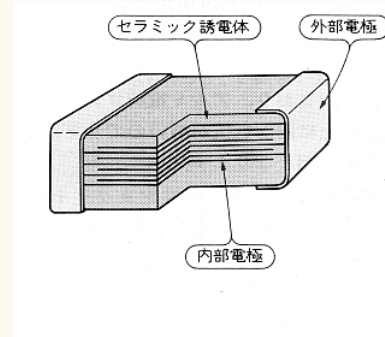

Film capacitors

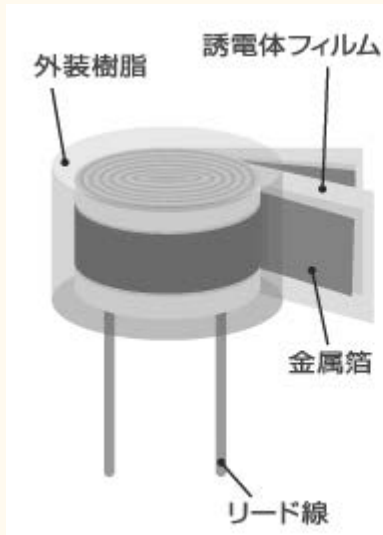

誘導

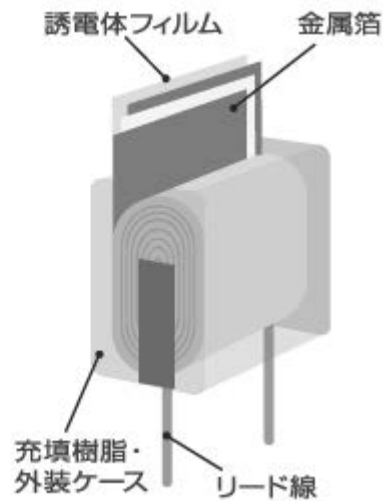

無誘導

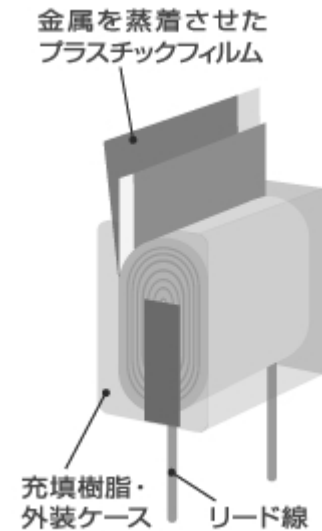

蒸着無誘導



Chemical capacitors

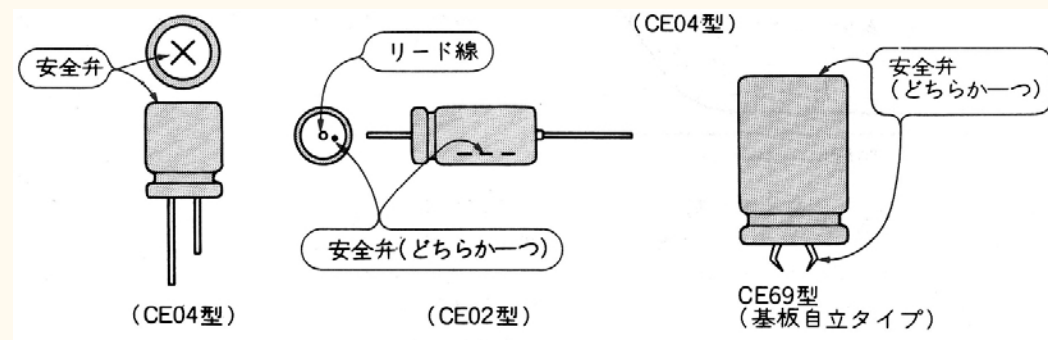
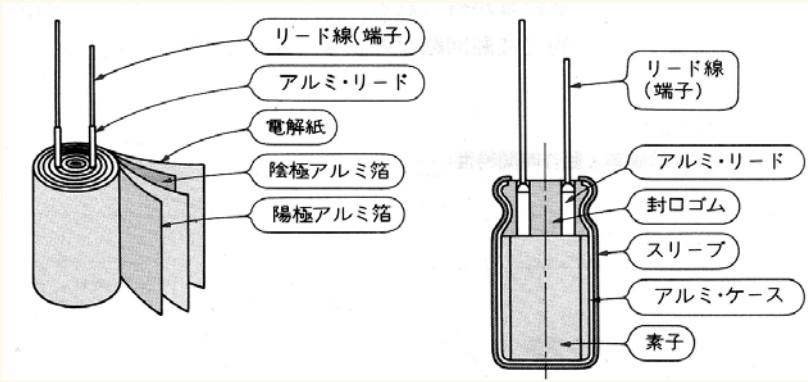

タンタル電解

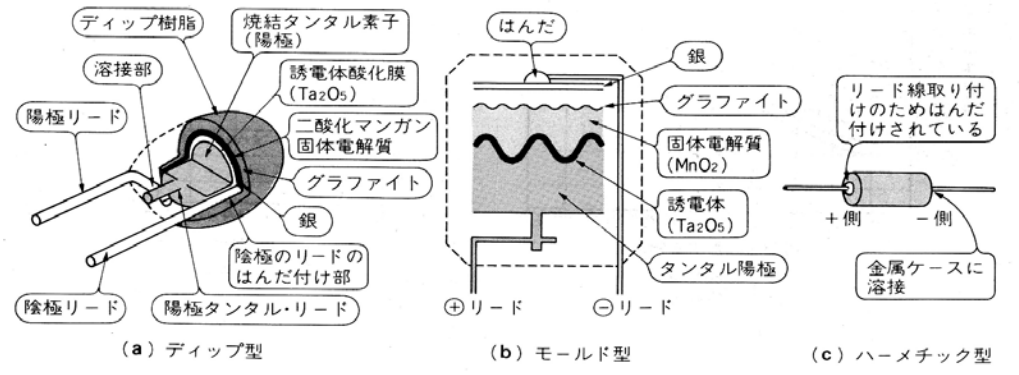

Surface mount chip capacitors

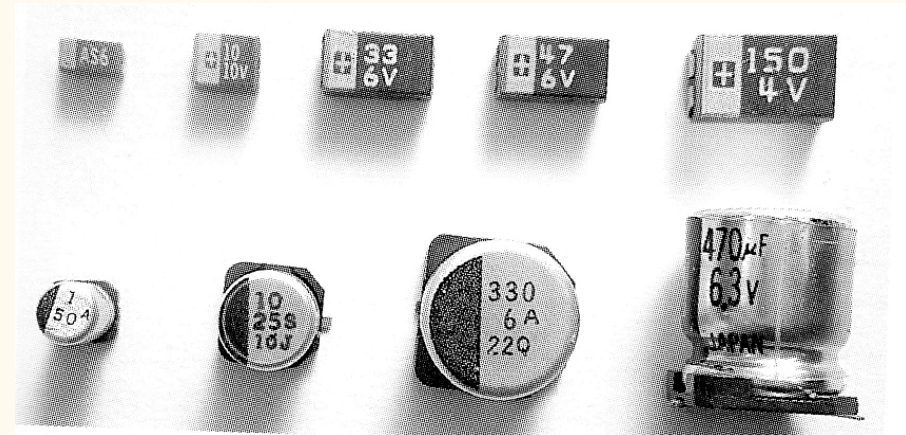
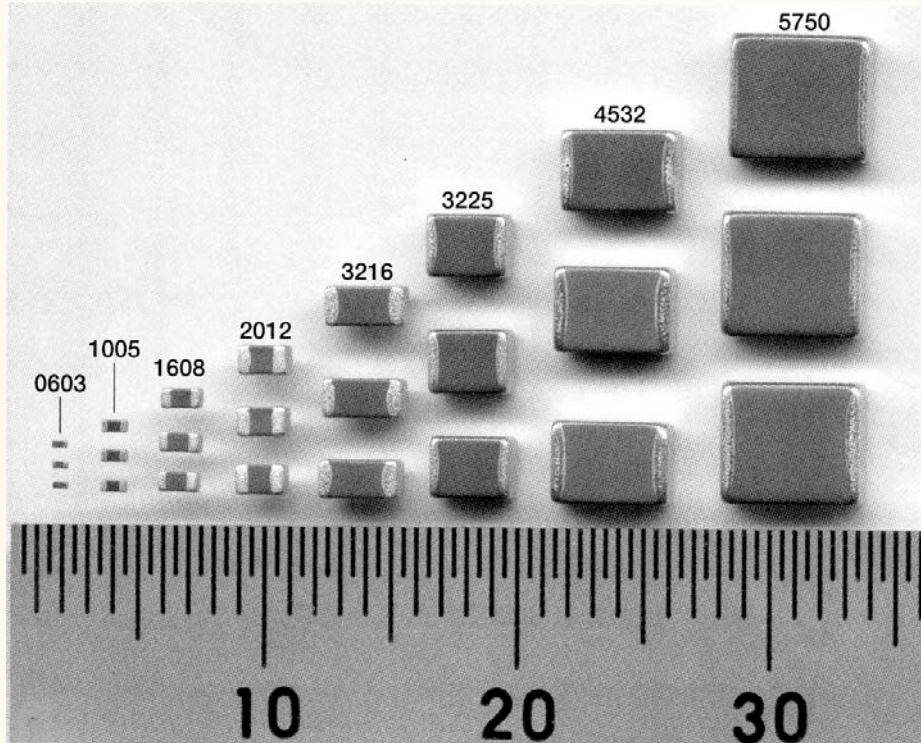

Variable inductors

$$L = K \times \mu \frac{N^2}{l} S = K \times \mu n N S$$

$$K(\text{Nagaoka coef.}) = \frac{4}{3\pi\sqrt{1-k^2}} \left[\frac{1-k^2}{k^2} K(k) - \frac{1-2k^2}{k^2} E(k) - k \right]$$

$$\frac{L}{2a} = \frac{\sqrt{1-k^2}}{k}$$

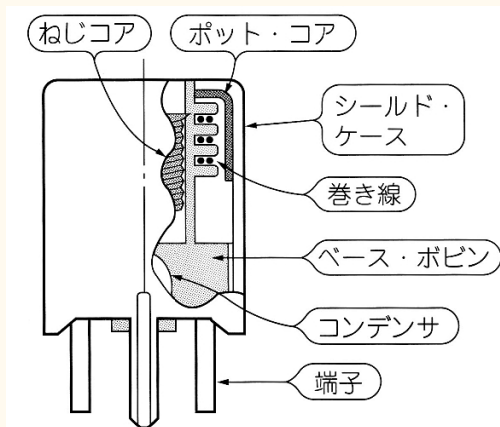

Fixed inductors

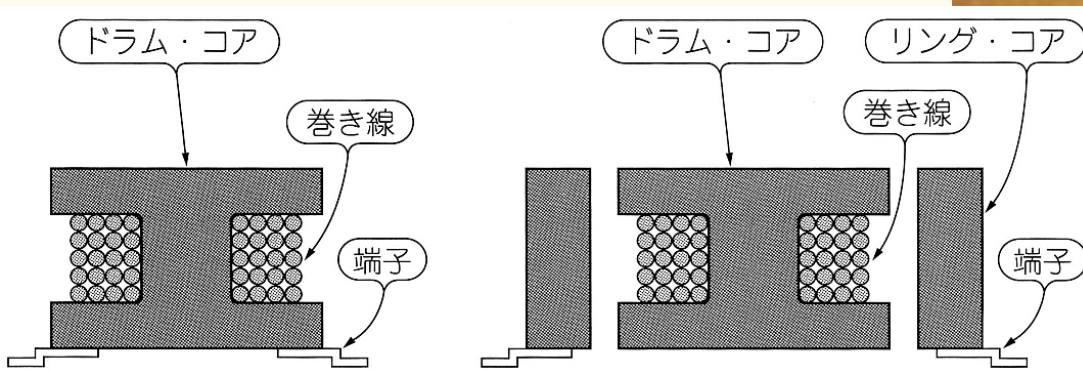

Open flux path

Closed flux path

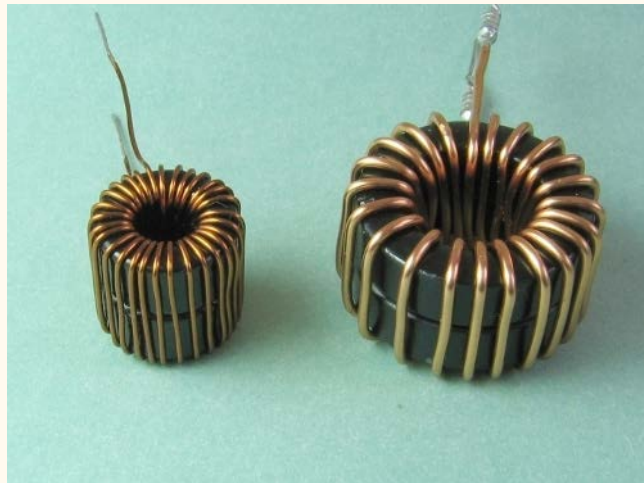

Toroidal coil

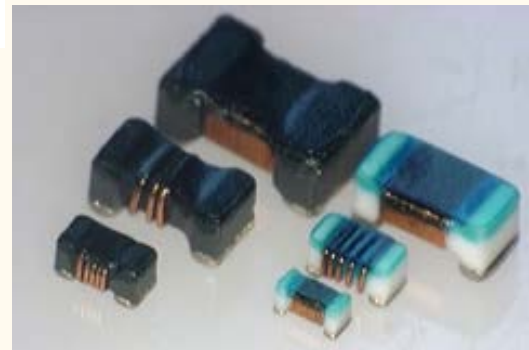

Chip inductor



Ch.2 Introduction to linear circuits

2.1 Linear system and electric circuit

2.1.1 What is linear system?

$$f(C_1x_1 + C_2x_2) = C_1f(x_1) + C_2f(x_2)$$

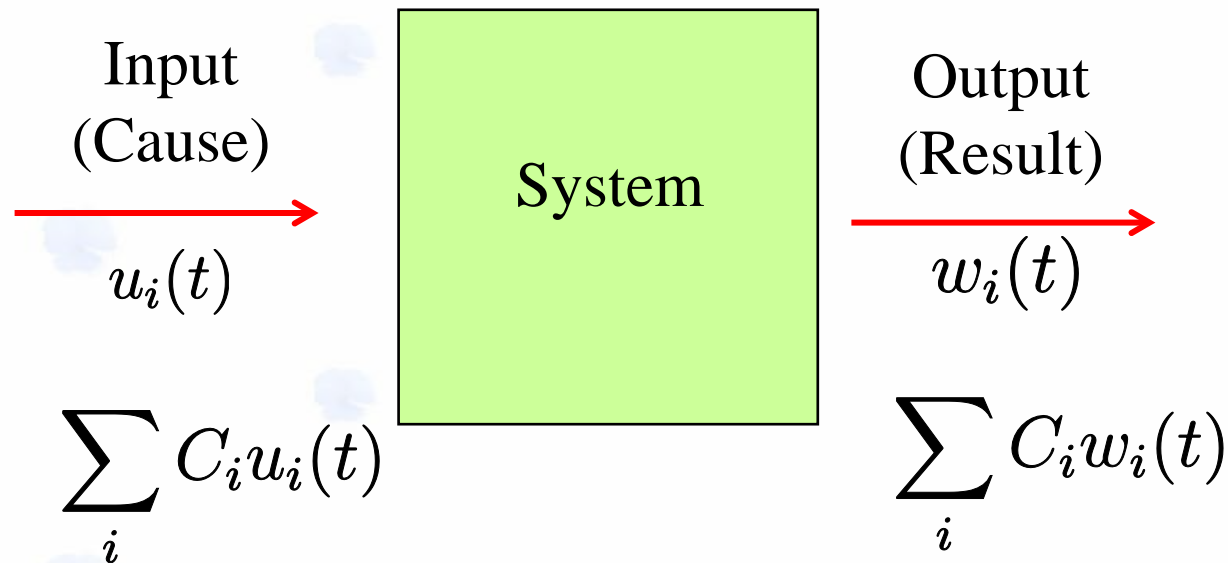

Linear system: definition

$$w(t) = \mathcal{R}\{u(t)\} \quad : \text{Response}$$

Requirements

$$\text{Invariance: } \forall t_1 \quad w(t - t_1) = \mathcal{R}\{u(t - t_1)\}$$

$$\text{Causality: } u(t) = 0 \ (t < t_1) \rightarrow w(t) = 0 \ (t < t_1)$$

Principle of superposition:

$$\forall C_1, C_2 \in C, \quad \mathcal{R}\{C_1 u_1(t) + C_2 u_2(t)\} = C_1 w_1(t) + C_2 w_2(t)$$

$$\mathcal{R}\left\{\sum_i C_i u_i(t)\right\} = \sum_i C_i w_i(t)$$

$$\mathcal{R}\left\{\int_{-\infty}^{\infty} c(q) u(q, t) dq\right\} = \int_{-\infty}^{\infty} c(q) \mathcal{R}\{u(q, t)\} dq$$

Transfer function

Variable $q \rightarrow$ time t

$$c(t) = \begin{cases} 1 & |t| \leq \delta t/2, \\ 0 & \text{others} \end{cases}$$

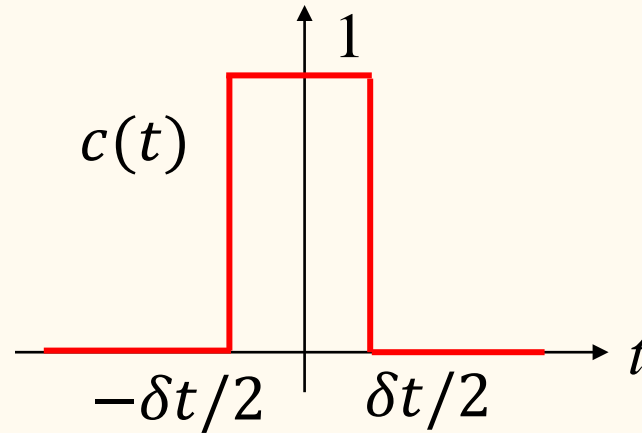

$$u(t) = \sum_i u(t_i) c(t - t_i) \quad \rightarrow \quad u(t) = \int_{-\infty}^{\infty} dt' u(t') c'(t - t')$$

$$c'(t - t') = \delta(t - t')$$

$$\begin{aligned} w(t) &= \mathcal{R}\{u(t)\} = \mathcal{R}\left\{\int_{-\infty}^{\infty} u(t') \delta(t - t') dt'\right\} \\ &= \int_{-\infty}^{\infty} u(t') \mathcal{R}\{\delta(t - t')\} dt' = \int_{-\infty}^{\infty} u(t') \xi(t, t') dt' \end{aligned}$$

Transfer function (Impulse response)

$\xi(t, t') \equiv \mathcal{R}\{\delta(t - t')\}$: Impulse response, weight function

Invariance $\rightarrow \xi(t, t_1) = \xi(t - t_1)$

$$w(t) = \int_{-\infty}^{\infty} u(t')\xi(t - t')dt' = \int_{-\infty}^{\infty} u(t - t')\xi(t')dt'$$

Convolution

Fourier transform:

$$X(\omega) = \int_{-\infty}^{\infty} x(t)e^{-i\omega t}dt, \quad x(t) = \int_{-\infty}^{\infty} X(\omega)e^{i\omega t}\frac{d\omega}{2\pi}$$

$$W(\omega) = U(\omega)\underline{\Xi(\omega)}$$

Transfer function



Summary

1. Electromagnetic field and electric circuits

Metals: super screening material

Circuit diagrams

Local electromagnetic field

2. Introduction to linear circuits

Transfer function