

「半導体」第9回

物性研究所
勝本信吾

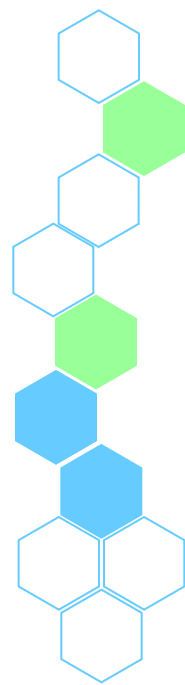



準フェルミ準位

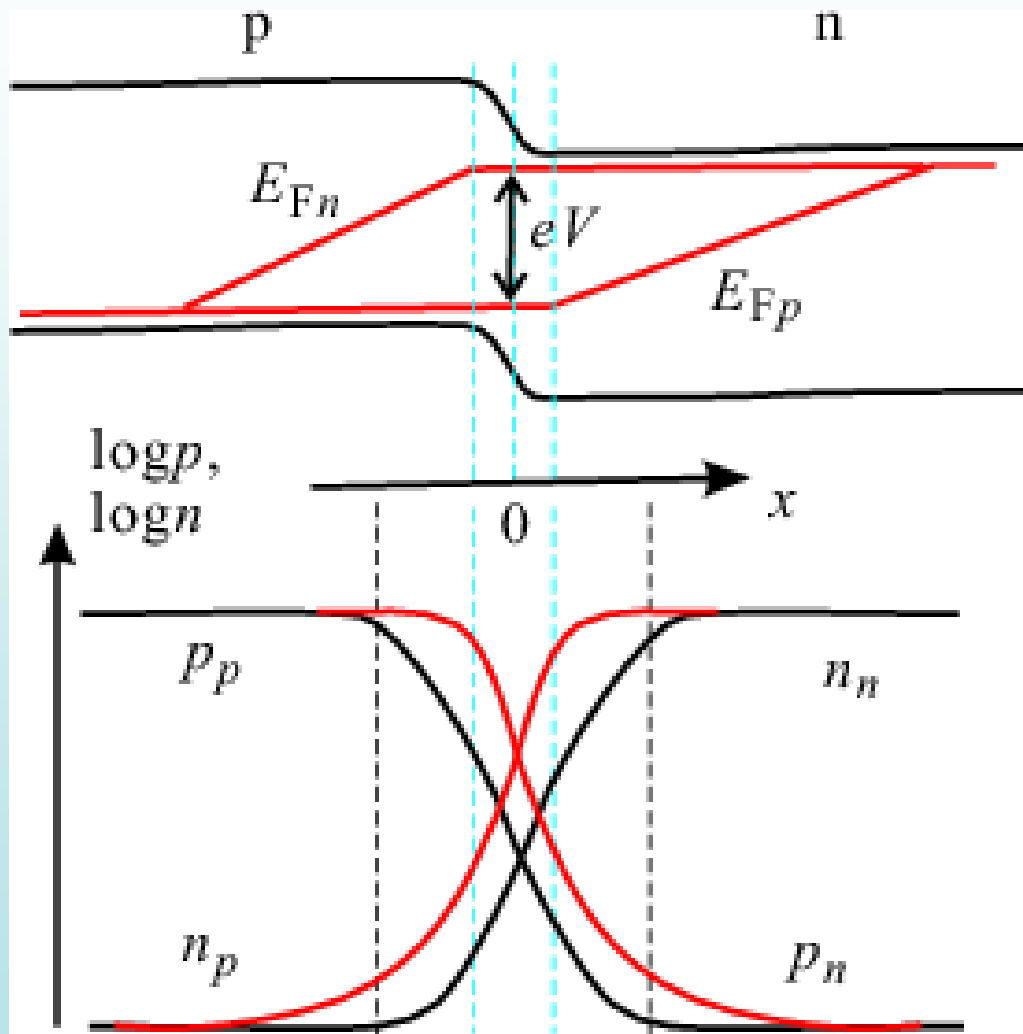

$$E_{Fn} \equiv E_i + k_B T \ln \left(\frac{n}{n_i} \right),$$

$$E_{Fp} \equiv E_i - k_B T \ln \left(\frac{p}{n_i} \right).$$



Solar cell (injection of minority carriers)

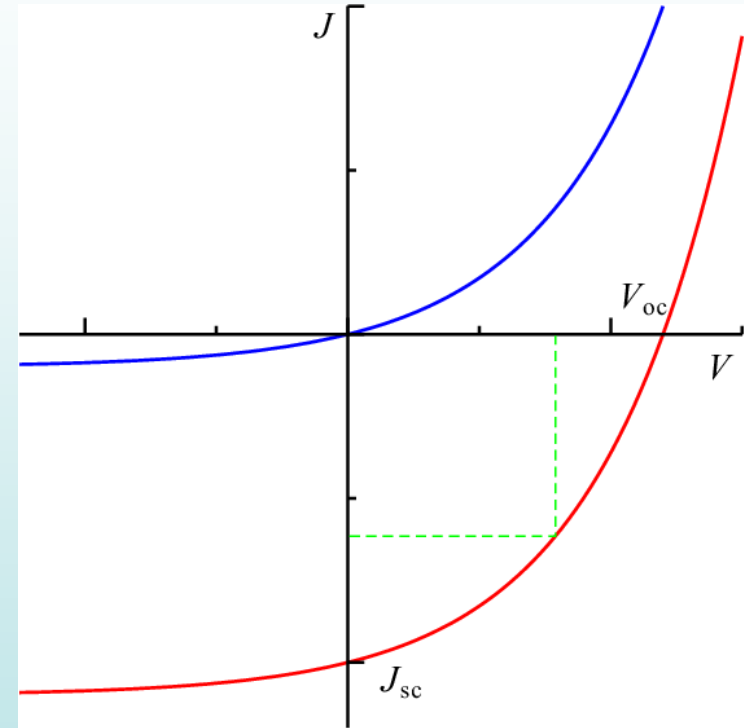
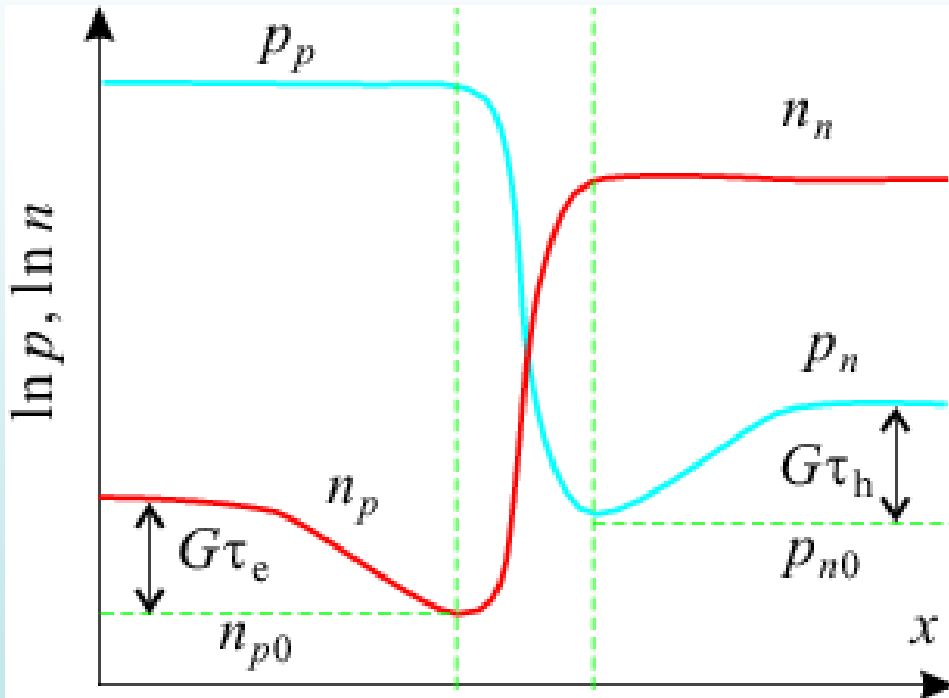



接合トランジスタの特性

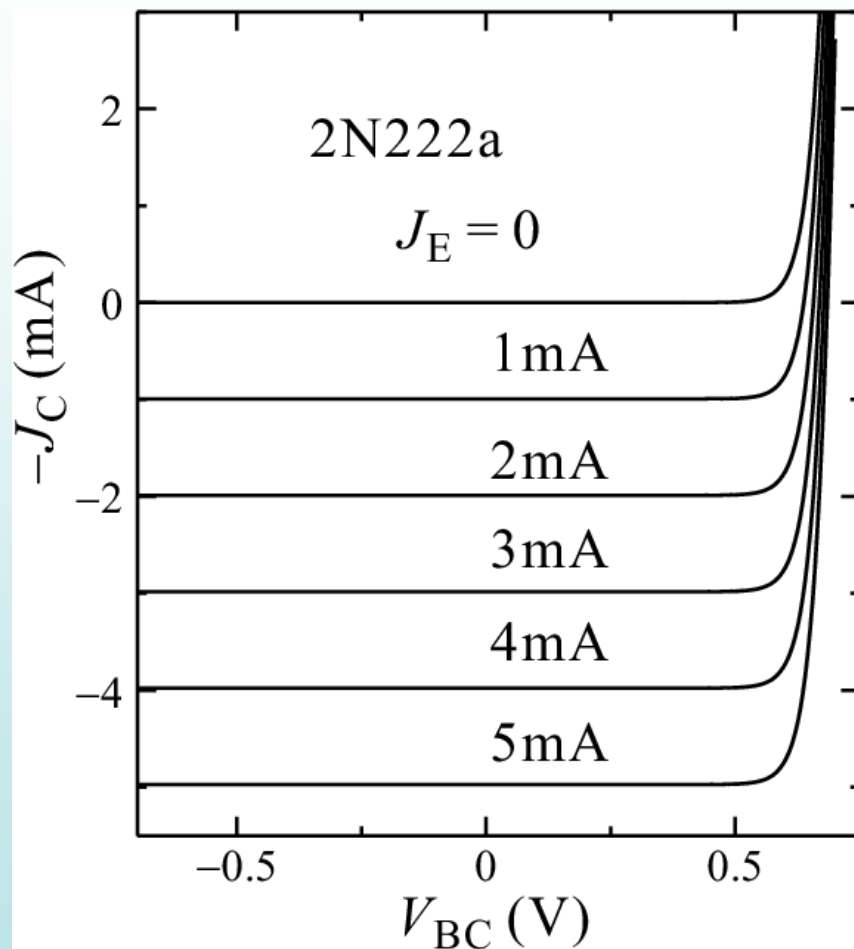
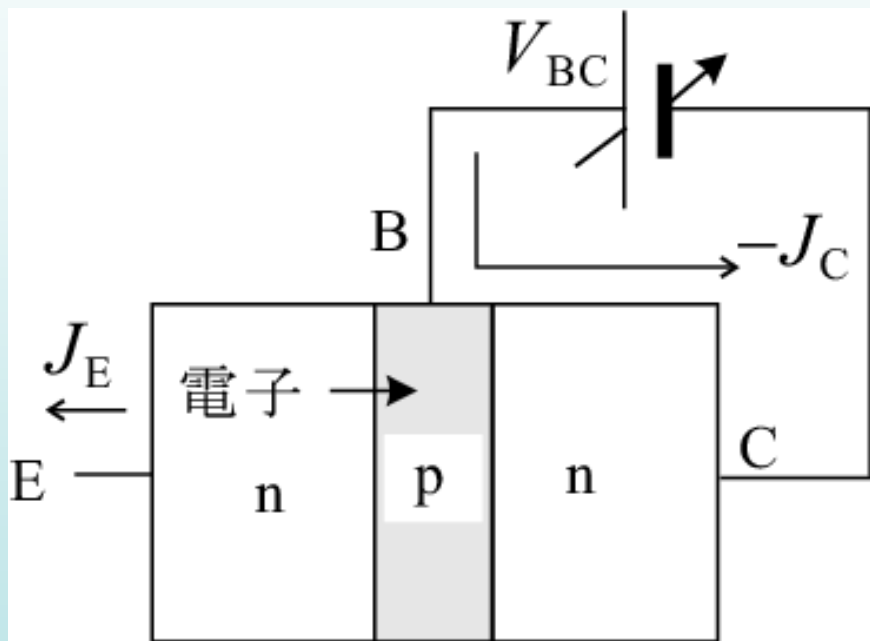



接合トランジスタの特性(2)

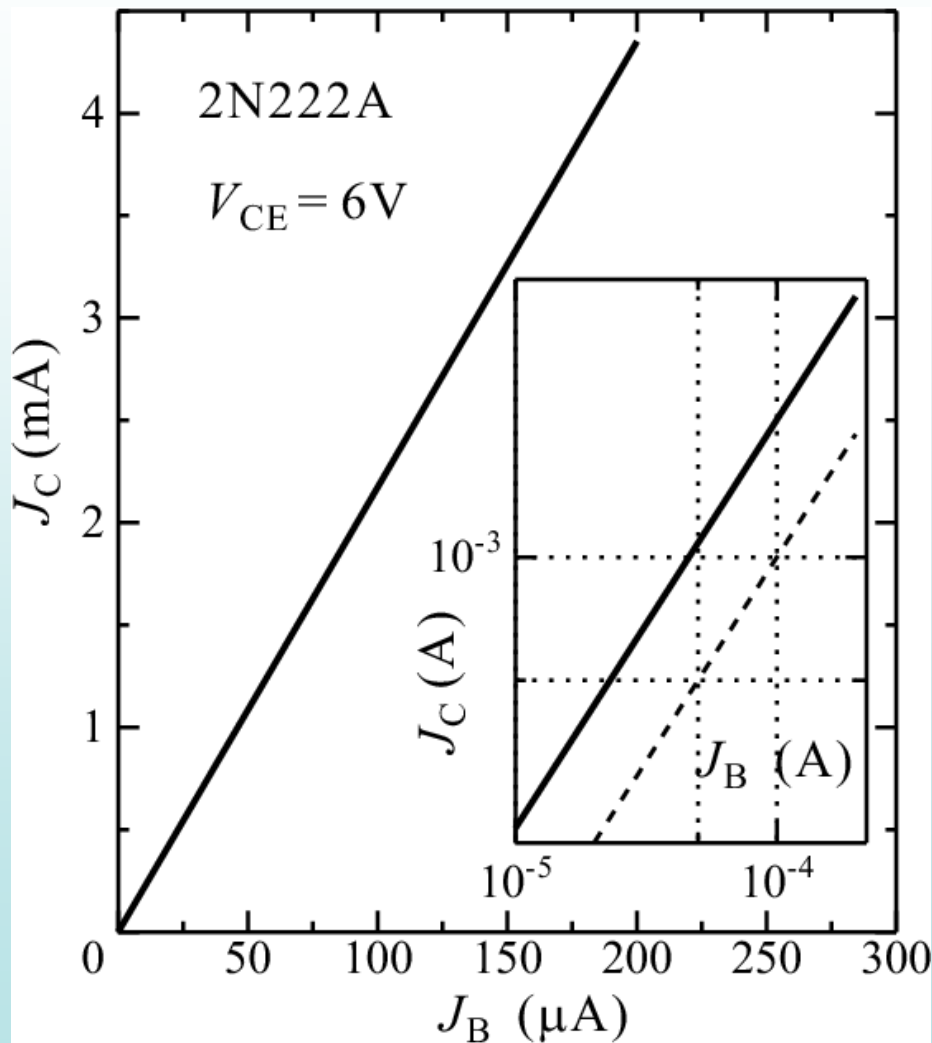
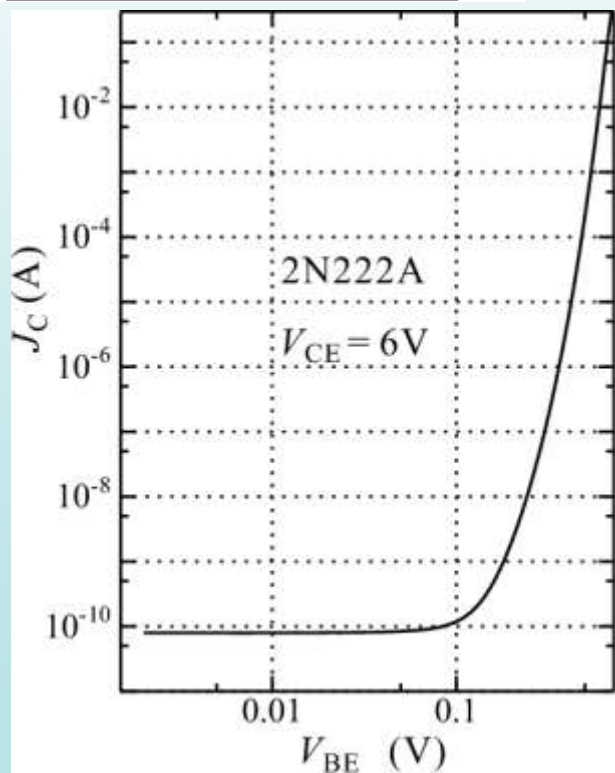
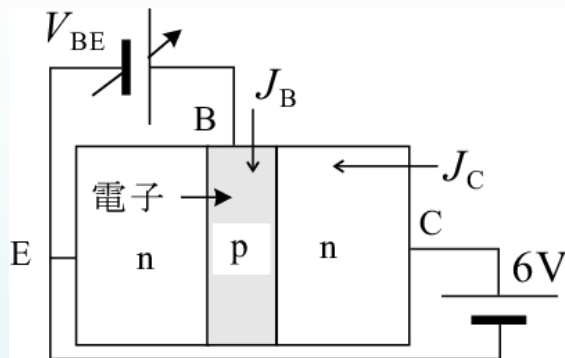

JFET

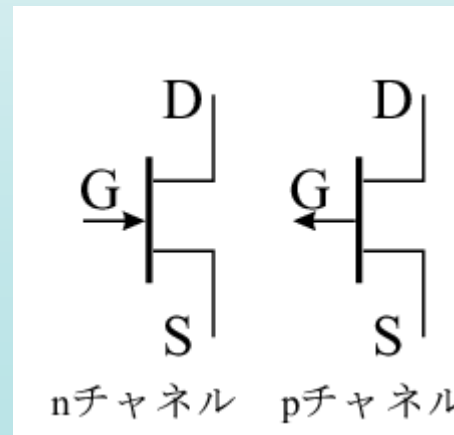
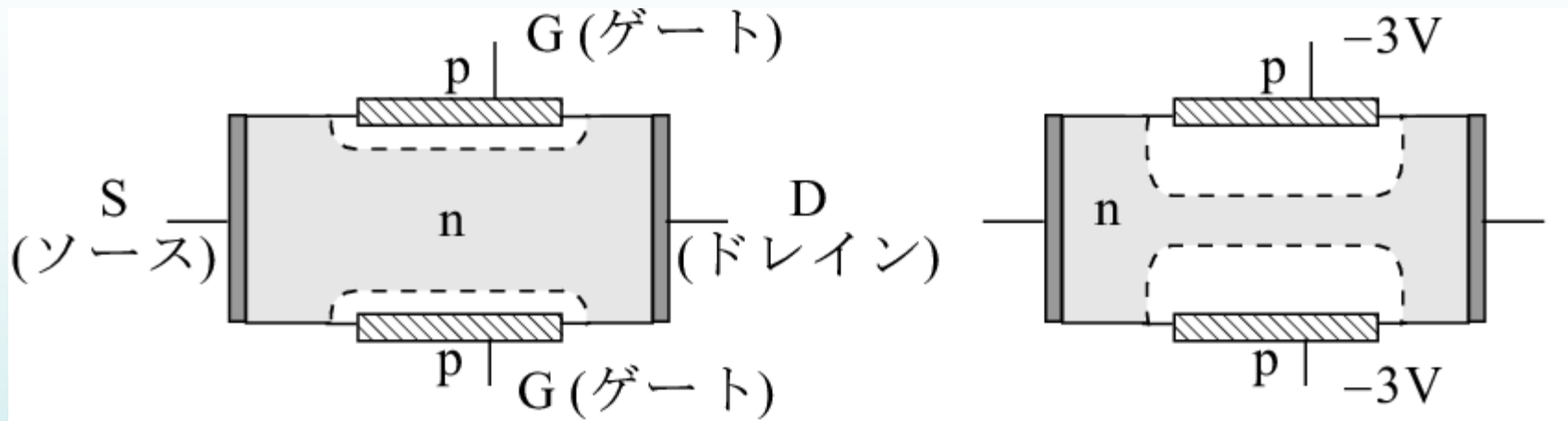

MESFET, MOSFET

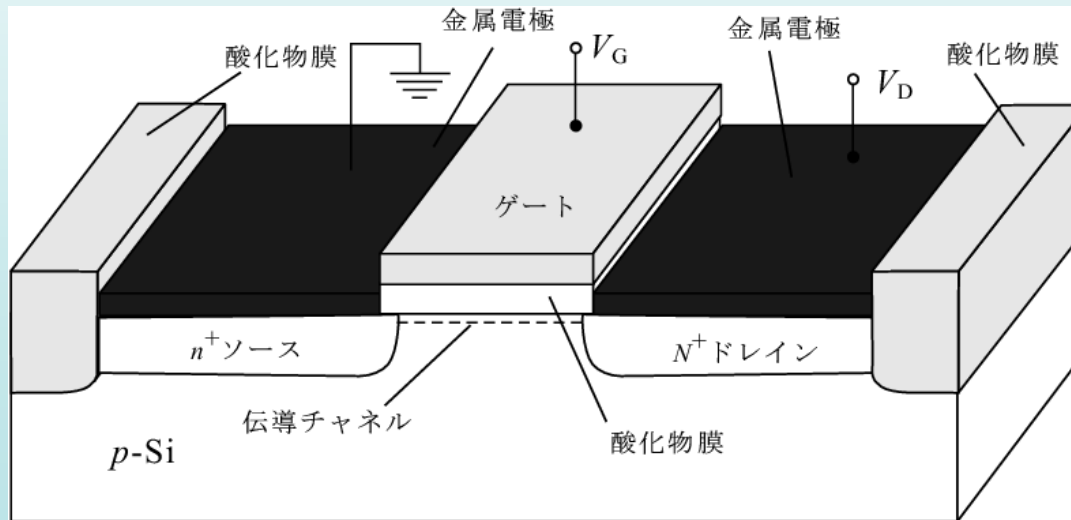
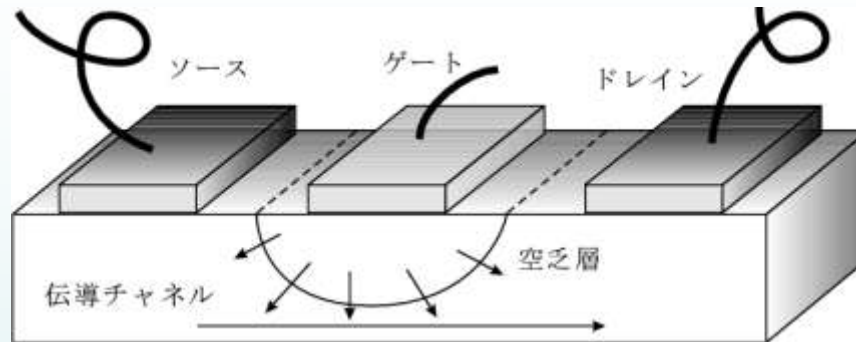

E_g vs a

